

GRAND PRIX S

OPRAWY ZEWNĘTRZNE / СВЕТИЛЬНИКИ УЛИЧНЫЕ



● Szary RAL 9006 (.02) / Серый RAL 9006 (.02)

Poziom ochrony: IP66; IK09
Уровень защиты: IP66; IK09

Klasa izolacji: I lub II
Napięcie zasilania: 220 - 240V 50Hz
Temperatura pracy opraw Ta: - 25°C do +35°C

.02 kolor oprawy
Цвет корпуса

.YYY typ LED, standard: 730; 740; 757; 840
Тип СИД, стандарт: 730; 740; 757; 840

.ZZZ typ soczewki, patrz następna strona
Тип линзы, см. следующую страницу

Obudowa jednokomorowa.
однокамерный корпус.

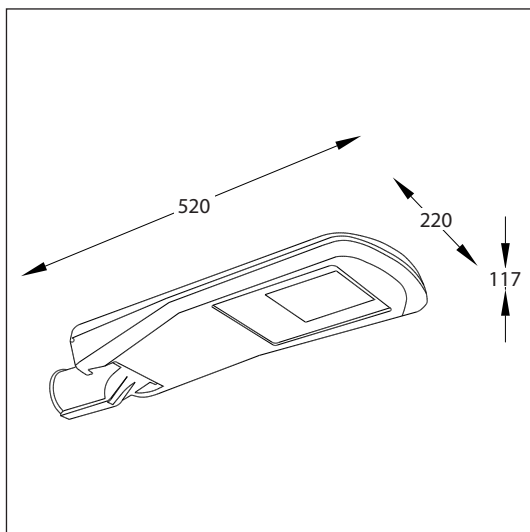

GRAND PRIX S

						∅
90.0040.02.YYY.ZZZ	2x(2x4)	12W	1960lm	3.1kg	48-60	
90.0041.02.YYY.ZZZ	2x(2x4)	19W	2800lm	3.1kg	48-60	
90.0042.02.YYY.ZZZ	2x(2x4)	25W	3500lm	3.1kg	48-60	
90.0043.02.YYY.ZZZ	2x(2x4)	39W	4700lm	3.1kg	48-60	
90.0120.02.YYY.ZZZ	2x(2x6)	24W	3900lm	3.1kg	48-60	
90.0121.02.YYY.ZZZ	2x(2x6)	37W	5600lm	3.1kg	48-60	

GRAND PRIX S

OPRAWY ZEWNĘTRZNE / СВЕТИЛЬНИКИ УЛИЧНЫЕ

MF-WIDE 2

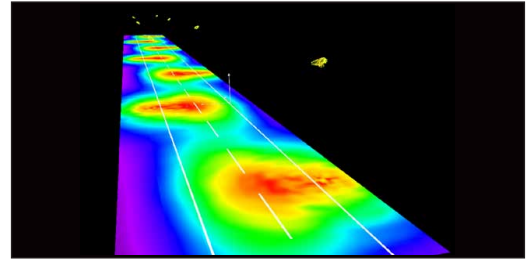
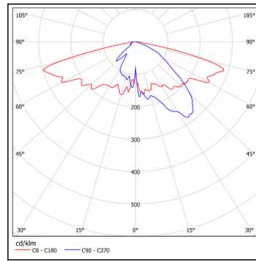

DWC

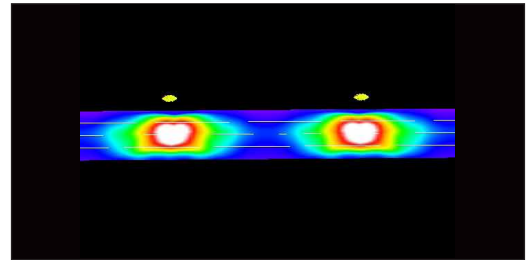
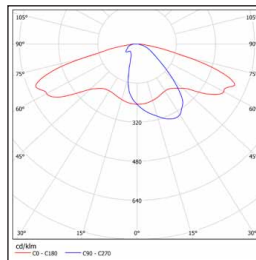

CY

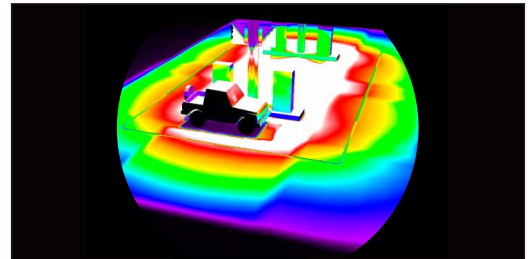
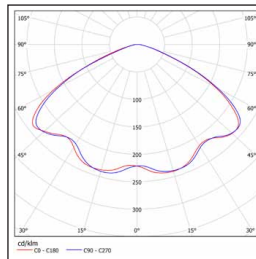

VSM

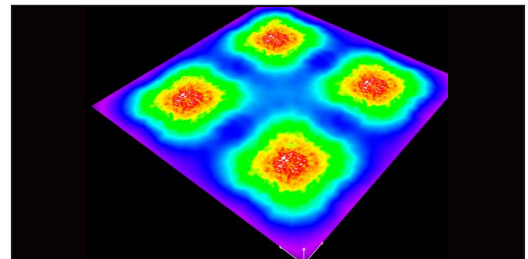
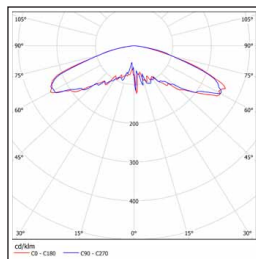

MEW

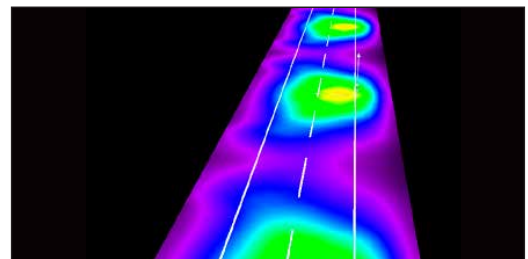
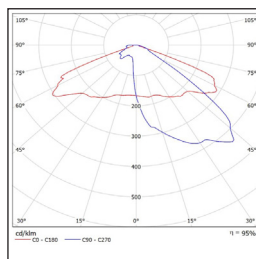

SCL

